

Key-in-lever locksets



ASSA ABLOY

Squaring the advantages

- » Multifunctional mechanism for knob or lever, with high component robustness and soft operation.
- » High-end commercial and residential applications.

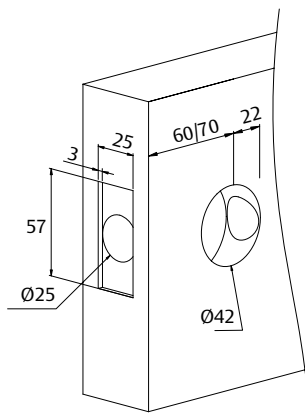

Dimensions in mm

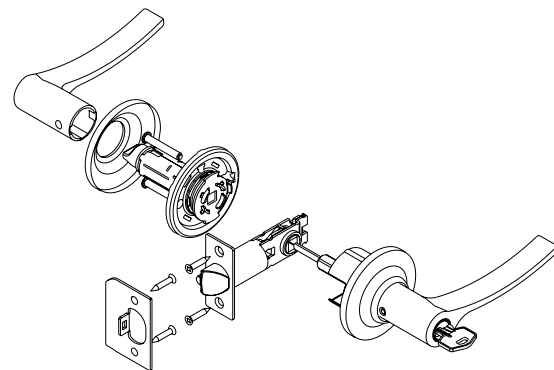







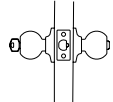
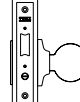
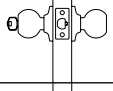

Features	Standard	Special
Technical features	Anti-thrust security pin for functions 0, 1 and 2.	Panic release system: in key models, even when locked, the door can always be opened from inside.
Anti-corrosion resistance ASTM B117/90	CR,CM,NS ... 144 hours LP,LM... 96 hours	
Door thickness	33-45 mm for handles. 33-52 mm for knobs. Except function 07: 40-50mm	Up to 75 mm
ANSI A156.2	Grade 2: 400.000 cycles.	
UL		Up to 1,5 hours of Fire proof
Cylinder	5 pin cylinder with 3 keys.	Security Cylinder: T60, T80, TX80, T10, T12. Masterkeying and keyed alike.
Latch	60/70 Adjustable backset. Latchbolt projection 12,5 mm	127 mm rounded forend.
Accessories	Strike, screws, instructions and assembly template.	Rounded strike.
Packaging units	20	
Reversibility	All knobsets are reversible - Beware with the hands of some handles	

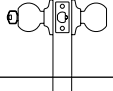
Pour plus d'informations, visitez www.tesa.es
ou envoyer un e-mail à marketing@tesa.es

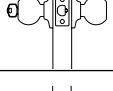
Key-in-lever locksets

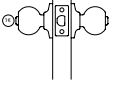
Functions

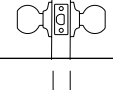
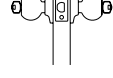
Function	Description	Function	Description
 00	ENTRANCE LOCK: both sides are locked and unlocked by outside key or inside turn-button.	 20	ENTRANCE LOCK: both sides are locked and unlocked by outside key or inside knob. Mortise lock. Applicable with electric strike.
 01	ENTRANCE LOCK: locked and unlocked only by outside key. If locked, inside knob/lever is not active.	 31	SINGLE DUMMY TRIM: screw attachment from inside of the door.
 01AP	ENTRANCE LOCK: locked and unlocked only by outside key. Inside always unlocked.	 32	DOUBLE DUMMY TRIM
 02	STOREROOM LOCK: outside fixed, entrance by key only. Inside always unlocked.	 33	ENTRANCE LOCK: both sides always unlocked. Applicable to mortise locks.
 03	BED AND BATHROOM LOCKS: both sides are locked and unlocked by the inside turn-button. Emergency release outside.	 34	ENTRANCE LOCK: always unlocked. Applicable to mortise locks.
 05	PASSAGE LOCK: both sides always unlocked.		
 07	OFFICE LOCK: key locks and unlocks each side separately. Leaf thickness: 40-50mm		

Code interpretation

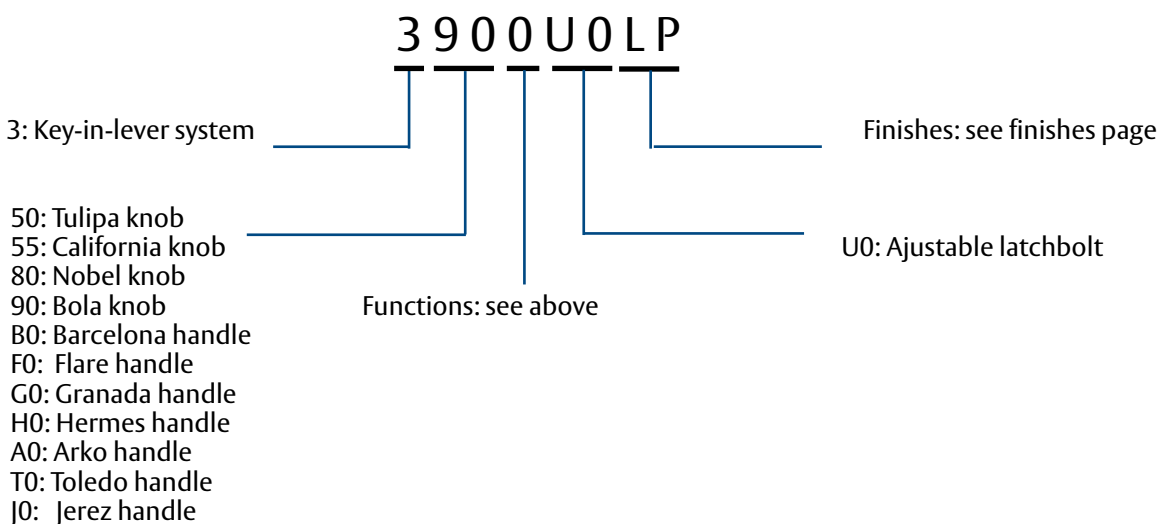

Key-in-lever locksets

Handle model

Model	A	B	C	Model	A	B	C
Arko	65	62	112	Hermes	65	62	109
Barcelona	65	62	109	Jerez	65	62	115
Flare	65	62	107	Toledo	65	62	121
Granada	65	62	119				

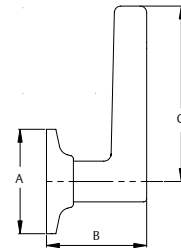

3A00 Arko 3B00 Barcelona



3F00 Flare 3G00 Granada



3H00 Hermes 3J00 Jerez



3T00 Toledo







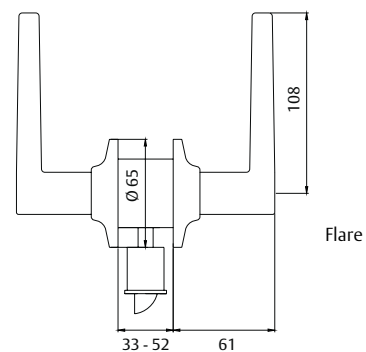



3F00 Flare series

Entrance	Function	Backset	Finish	Packging
	3F00	U0	CM - CR - LM - LP - NS LA - BL - NE	20
Storeroom	Function	Backset	Finish	Packging
	3F02D	U0	CM - CR - LM - LP - NS LA - BL - NE	20
Storeroom	Function	Backset	Finish	Packging
	3F02I	U0	CM - CR - LM - LP - NS LA - BL - NE	20
Bathroom	Function	Backset	Finish	Packging
	3F03	U0	CM - CR - LM - LP - NS LA - BL - NE	20
Passage	Function	Backset	Finish	Packging
	3F05	U0	CM - CR - LM - LP - NS LA - BL - NE	20
Offices	Function	Backset	Finish	Packging
	3F07	U0	CM - CR - LM - LP - NS LA - BL - NE	20
Pull lever	Function	Backset	Finish	Packging
	3F34D	00	CM - CR - LM - LP - NS LA - BL - NE	20
Single spindle	Function	Backset	Finish	Packging
	3F34I	00	CM - CR - LM - LP - NS LA - BL - NE	20









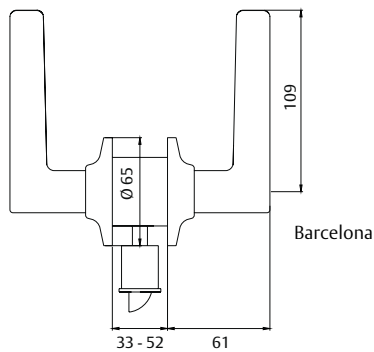

Key-in-lever locksets

3B00 Barcelona series

Entrance	Function	Backset	Finish	Packging
	3B00	U0	CM - CR - LM - LP - NS LA - BL - NE	20
Storeroom	Function	Backset	Finish	Packging
	3B02D	U0	CM - CR - LM - LP - NS LA - BL - NE	20
Storeroom	Function	Backset	Finish	Packging
	3B02I	U0	CM - CR - LM - LP - NS LA - BL - NE	20
Bathroom	Function	Backset	Finish	Packging
	3B03	U0	CM - CR - LM - LP - NS LA - BL - NE	20
Passage	Function	Backset	Finish	Packging
	3B05	U0	CM - CR - LM - LP - NS LA - BL - NE	20
Office	Function	Backset	Finish	Packging
	3T07	U0	CM - CR - LM - LP - NS LA - BL - NE	20
Single spindle	Function	Backset	Finish	Packging
	3B34D	00	CM - CR - LM - LP - NS LA - BL - NE	20
Single spindle	Function	Backset	Finish	Packging
	3B34I	00	CM - CR - LM - LP - NS LA - BL - NE	20







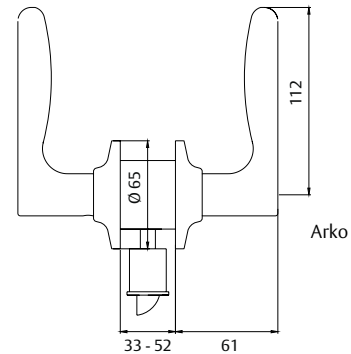



3A00 Arko series

Entrance	Function	Backset	Finish	Packging
	3A00	U0	CM - CR - LM - LP - NS LA - BL - NE	20
Storeroom	Function	Backset	Finish	Packging
	3A02D	U0	CM - CR - LM - LP - NS LA - BL - NE	20
Storeroom	Function	Backset	Finish	Packging
	3A02I	U0	CM - CR - LM - LP - NS LA - BL - NE	20
Bathroom	Function	Backset	Finish	Packging
	3A03	U0	CM - CR - LM - LP - NS LA - BL - NE	20
Passage	Function	Backset	Finish	Packging
	3A05	U0	CM - CR - LM - LP - NS LA - BL - NE	20
Office	Function	Backset	Finish	Packging
	3A07	U0	CM - CR - LM - LP - NS LA - BL - NE	20
Single spindle	Function	Backset	Finish	Packging
	3A34D	00	CM - CR - LM - LP - NS LA - BL - NE	20
Single spindle	Function	Backset	Finish	Packging
	3A34I	00	CM - CR - LM - LP - NS LA - BL - NE	20







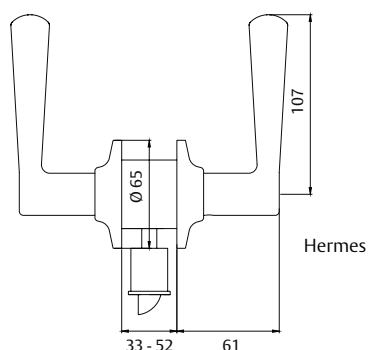

Key-in-lever locksets

3H00 Hermes series

Entrance	Function	Backset	Finish	Packging
	3H00	U0	CM - CR - LM - LP - NS LA - BL - NE	20
Storeroom	Function	Backset	Finish	Packging
	3H02D	U0	CM - CR - LM - LP - NS LA - BL - NE	20
Storeroom	Function	Backset	Finish	Packging
	3H02I	U0	CM - CR - LM - LP - NS LA - BL - NE	20
Bathroom	Function	Backset	Finish	Packging
	3H03	U0	CM - CR - LM - LP - NS LA - BL - NE	20
Passage	Function	Backset	Finish	Packging
	3H05	U0	CM - CR - LM - LP - NS LA - BL - NE	20
Office	Function	Backset	Finish	Packging
	3H07	U0	CM - CR - LM - LP - NS LA - BL - NE	20
Single spindle	Function	Backset	Finish	Packging
	3H34D	00	CM - CR - LM - LP - NS LA - BL - NE	20
Single spindle	Function	Backset	Finish	Packging
	3H34I	00	CM - CR - LM - LP - NS LA - BL - NE	20







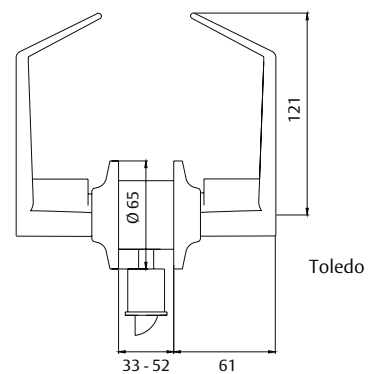

3T00 Toledo series

Entrance	Function	Backset	Finish	Packging
	3T00	U0	CM - CR - LM - LP - NS LA - BL - NE	20
Storeroom	Function	Backset	Finish	Packging
	3T02	U0	CM - CR - LM - LP - NS LA - BL - NE	20
Bathroom	Function	Backset	Finish	Packging
	3T03	U0	CM - CR - LM - LP - NS LA - BL - NE	20
Passage	Function	Backset	Finish	Packging
	3T05	U0	CM - CR - LM - LP - NS LA - BL - NE	20
Office	Function	Backset	Finish	Packging
	3T07	U0	CM - CR - LM - LP - NS LA - BL - NE	20
Single spindle	Function	Backset	Finish	Packging
	3T34	00	CM - CR - LM - LP - NS LA - BL - NE	20







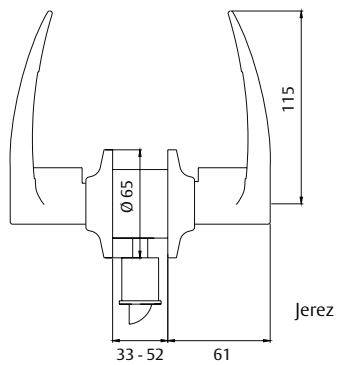

Key-in-lever locksets

3J00 Jerez series

Entrance	Function	Backset	Finish	Packging
	3J00	U0	CM - CR - LM - LP - NS LA - BL - NE	20
Storeroom	Function	Backset	Finish	Packging
	3J02	U0	CM - CR - LM - LP - NS LA - BL - NE	20
Bathroom	Function	Backset	Finish	Packging
	3J03	U0	CM - CR - LM - LP - NS LA - BL - NE	20
Passage	Function	Backset	Finish	Packging
	3J05	U0	CM - CR - LM - LP - NS LA - BL - NE	20
Office	Function	Backset	Finish	Packging
	3J07	U0	CM - CR - LM - LP - NS LA - BL - NE	20
Single spindle	Function	Backset	Finish	Packging
	3J34	00	CM - CR - LM - LP - NS LA - BL - NE	20



3G00 Granada series



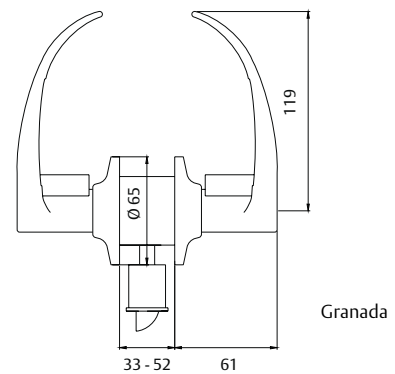



Entrance	Function	Backset	Finish	Packging
	3G00	U0	CM - CR - LM - LP - NS LA - BL - NE	20
Storeroom	Function	Backset	Finish	Packging
	3G02	U0	CM - CR - LM - LP - NS LA - BL - NE	20
Bathroom	Function	Backset	Finish	Packging
	3G03	U0	CM - CR - LM - LP - NS LA - BL - NE	20
Passage	Function	Backset	Finish	Packging
	3G05	U0	CM - CR - LM - LP - NS LA - BL - NE	20
Office	Function	Backset	Finish	Packging
	3G07	U0	CM - CR - LM - LP - NS LA - BL - NE	20
Single spindle	Function	Backset	Finish	Packging
	3G34	00	CM - CR - LM - LP - NS LA - BL - NE	20



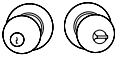



E

Key-in-lever locksets

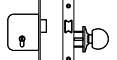
3900 Bola series

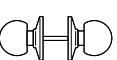
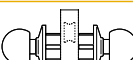
Entrance	Function	Backset	Finish	Packging
	3900	U0 UV	CM - CR - LM - LP - NS LA - BL - NE - AE	20
Entrance	Function	Backset	Finish	Packging
	3901	U0	CM - CR - LM - LP - NS LA - BL - NE - AE	20
Entrance	Function	Backset	Finish	Packging
	3901AP	U0	CCM - CR - LM - LP - NS LA - BL - NE - AE	20
Storeroom	Function	Backset	Finish	Packging
	3902	U0	CM - CR - LM - LP - NS LA - BL - NE - AE	20
Bathroom	Function	Backset	Finish	Packging
	3903	U0 UV	CM - CR - LM - LP - NS LA - BL - NE - AE	20
Passage	Function	Backset	Finish	Packging
	3905	U0 UV	CM - CR - LM - LP - NS LA - BL - NE - AE	20



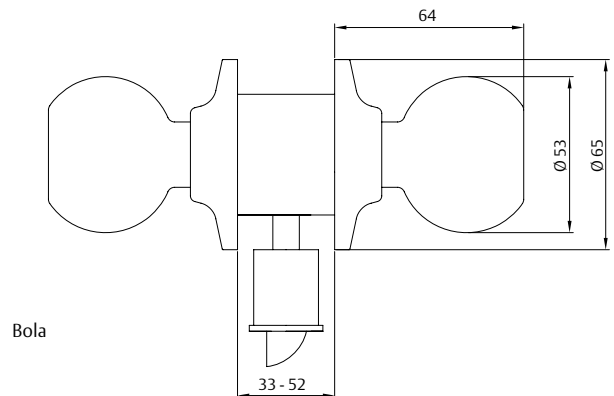



Office	Function	Backset	Finish	Packging
	3907	U0	CM - CR - LM - LP - NS LA - BL - NE - AE	20
Entrance	Function	Backset	Finish	Packging
	3920	50	CM - CR - LM - LP - NS LA - BL - NE - AE	20
Single pull knob	Function	Backset	Finish	Packging
	3931	00	CM - CR - LM - LP - NS LA - BL - NE - AE	20
Double pull knob	Function	Backset	Finish	Packging
	3932	00	CM - CR - LM - LP - NS LA - BL - NE - AE	20
Double sq.spindle	Function	Backset	Finish	Packging
	3933	00	CM - CR - LM - LP - NS LA - BL - NE - AE	20
Single sq.spindle	Function	Backset	Finish	Packging
	3934	00	CM - CR - LM - LP - NS LA - BL - NE - AE	20

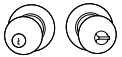
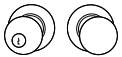
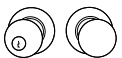
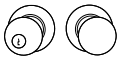
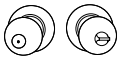
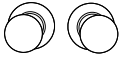

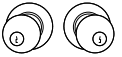
Key-in-lever locksets

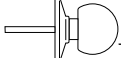
3500 Tulipa series

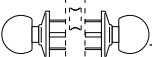

Entrance	Function	Backset	Finish	Packging
	3500	U0 UV	CM - CR - LM - LP - NS LA - BL - NE - AE	20
Entrance	Function	Backset	Finish	Packging
	3501	U0	CM - CR - LM - LP - NS LA - BL - NE - AE	20
Entrance	Function	Backset	Finish	Packging
	3501AP	U0	CM - CR - LM - LP - NS LA - BL - NE - AE	20
Storeroom	Function	Backset	Finish	Packging
	3502	U0	CM - CR - LM - LP - NS LA - BL - NE - AE	20
Bathroom	Function	Backset	Finish	Packging
	3503	U0 UV	CM - CR - LM - LP - NS LA - BL - NE - AE	20
Passage	Function	Backset	Finish	Packging
	3505	U0 UV	CM - CR - LM - LP - NS LA - BL - NE - AE	20

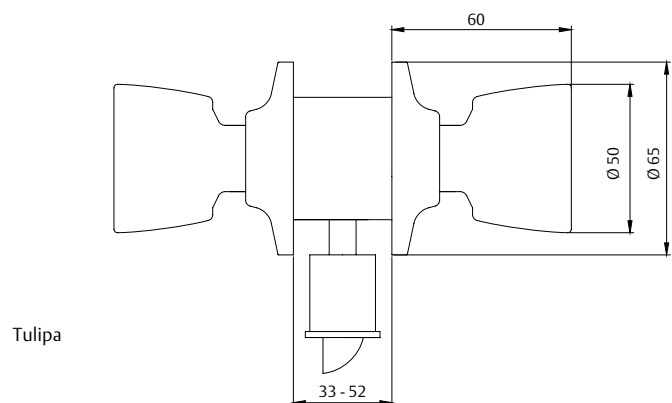
Office	Function	Backset	Finish	Packging
	3507	U0	CM - CR - LM - LP - NS LA - BL - NE - AE	20
Entrance	Function	Backset	Finish	Packging
	3520	U0	CM - CR - LM - LP - NS LA - BL - NE - AE	20
Single Pull knob	Function	Backset	Finish	Packging
	3531	U0	CM - CR - LM - LP - NS LA - BL - NE - AE	20
Double pull knob	Function	Backset	Finish	Packging
	3532	U0	CM - CR - LM - LP - NS LA - BL - NE - AE	20
Double sq.spindle	Function	Backset	Finish	Packging
	3533	U0	CM - CR - LM - LP - NS LA - BL - NE - AE	20
Single sq.spindle	Function	Backset	Finish	Packging
	3534	U0	CM - CR - LM - LP - NS LA - BL - NE - AE	20



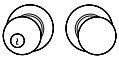
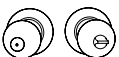

Key-in-lever locksets

3800 Nobel series

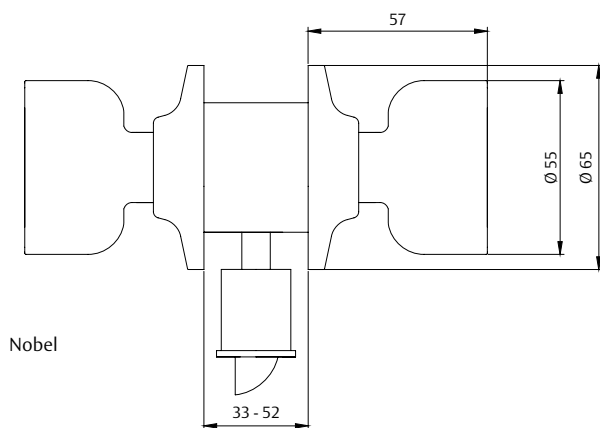
Entrance	Function	Backset	Finish	Packging
	3800	U0	CM - CR - LM - LP - NS LA	20
Storeroom	Function	Backset	Finish	Packging
	3802	U0	CM - CR - LM - LP - NS LA	20
Bathroom	Function	Backset	Finish	Packging
	3803	U0	CM - CR - LM - LP - NS LA	20
Passage	Function	Backset	Finish	Packging
	3805	U0	CM - CR - LM - LP - NS LA	20

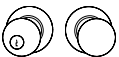

3550 California series

Entrance	Function	Backset	Finish	Packging
	3550	U0	CM - CR - LM - LP - NS LA	20
Storeroom	Function	Backset	Finish	Packging
	3552	U0	CM - CR - LM - LP - NS LA	20
Bathroom	Function	Backset	Finish	Packging
	3553	U0	CM - CR - LM - LP - NS LA	20
Passage	Function	Backset	Finish	Packging
	3555	U0	CM - CR - LM - LP - NS LA	20

