

# Latches and strikes

## Key-in-lever latch

Standard	Model	Finishes	Size	Packging
	P030U0	LP - CR	60/70	200
	P03020	LP - CR	127	100
1/2 rounded	Model	Finishes	Size	Packging
	P030U2	LP - CR	60/70	200
Security device	Model	Finishes	Size	Packging
	P031U0	LP - CR	60/70	200
	P03120	LP - CR	127	100
Security device and 1/2 rounded	Model	Finishes	Size	Packging
	P031U2	LP - CR	60/70	200

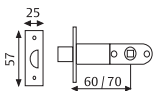
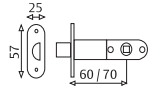
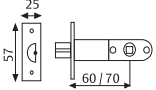
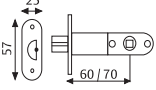
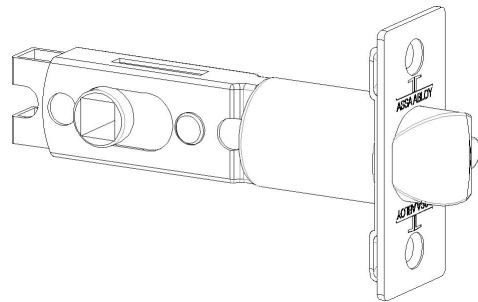

## Bolt for 516 and 517

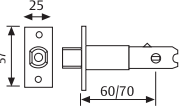
Standard	Model	Finishes	Size	Packging
	P016U0	LP - CR	60/70	200

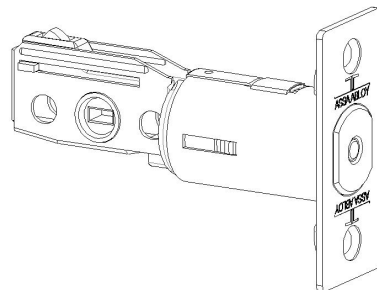

## Strikes

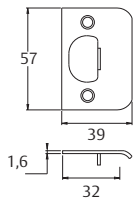
Standard	Model	Finishes	Packging
	C2500	HL	800
	C2500	HN	800

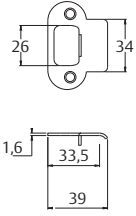
1/2 rounded	Model	Finishes	Packging
	CR25 / 34	HL	1000
	CR25 / 34	HN	1000

