

Panic exit devices Serie GLOBAL1E



ASSA ABLOY

Experience a safer
and more open world

GLOBAL1E is the new range of PANIC EXIT DEVICES for for mortise locks activated by means of a steel tube. It is CE certified according to UNE-EN1125 with a wide range of locks installed on doors located in escape routes and designed for a high traffic of people.

It stands out for its ease of installation and a new aesthetic based on new geometries of straight lines and the combination of different materials in the cover. Its easy reversibility, the possibility of having a cylinder inside and its wide range of finishes, measurements and accessories make it a versatile panic exit device that allows you to adjust it to the client's needs. Its mechanism is optimized to guarantee easy and fast evacuation in case of emergency at all times. It is certified for use on fire doors.



Anti
MICROBIAL



- Suitable for fire rated doors
- CE certified acc/EN1125 for the following assemblies:

3 7 6 B 1 3 2 2 A A

Single leaf doors	Distance between axes: 72 mm	Distance between axes: 85 mm	Narrow profile
PED	CF60	2035T/2037F/4039T	2230PA / 2240BA

Double leaf doors	Distance between axes: 72 mm		Distance between axes: 85 mm	
	Active leaf	Passive leaf	Active leaf	Passive leaf
PED	CF60	CF32	2035T/2037F/4039T	2032F

Technical characteristics

- TYPE A mortise panic device
- New design of mechanisms that offer optimal performance guaranteeing safety of people with very low opening forces.
- Certified according to EN1125: 2008 with the following locks: 2035T - 2037F - 4039T - 2032F - CF60 - CF32 - 2240BA - 2230PA
- 9 mm follower
- Reversible
- Narrow supports
- Cuttable
- Easy installation
 - Does not require a baseplate
 - Allows a previous installation of the mechanisms with cover to finish the installation of the anti-panic (arms and tube) at a later stage. This will protect the panic device from shocks and dirt during the execution phase of the work.
- Microswitch option
- Option of cylinder inside 72 mm and 85 mm
- Available in Antimicrobial coating

Aesthetics



- Combination of materials and finishes in the cover.
 - Cover with trim. (Figure 1)
- The cover lashing screws are hidden. (Figure 2)
- Tube geometry optimized to take advantage of to the maximum force applied on the panic exit device. (Figure 3)
- Cover closed on the inside without the need for a cover supplement. . (Figure 4)

Dimensions:

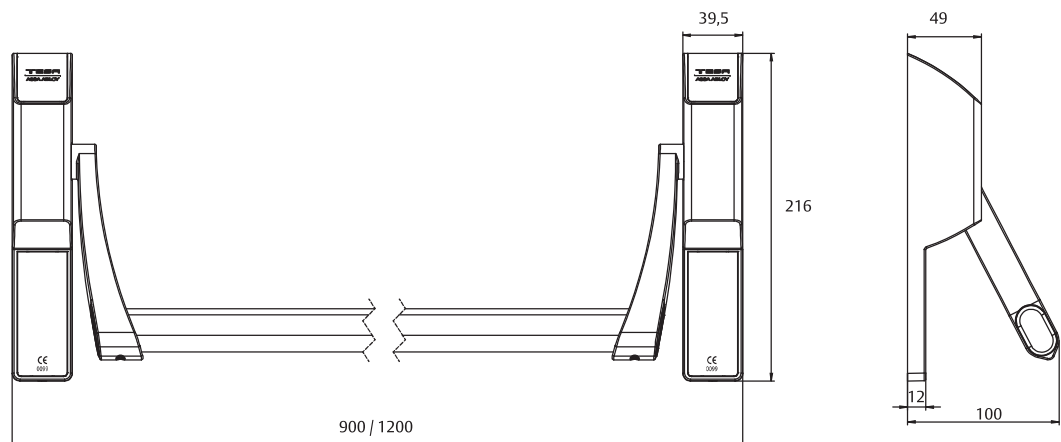

Finishes

Covers		Tube							
Cover	Side arm cover	Grey	Green	Red	Negro	Blanco	Titanium	SS	ACSS
Grey	Black	•	•	•	•				
White	Black					•			
Titanium	Black						•	•	•
Satin	Black							•	•
SS	-							•	•

SS: Stainless Steel ACSS: Antimicrobial coated stainless Steel

References according to finishes and lengths

Finish	Length (mm)	1 POINT
GREY - GREY	775	GL1E909GG
GREY - BLACK		GL1E909GN
GREY - RED		GL1E909GR
GREY - GREEN		GL1E909GV
TITANIUM - TITANIUM		GL1E909TT
WHITE - WHITE		GL1E909BB
TITANIUM - STAINLESS STEEL		GL1E909TI
SATIN - STAINLESS STEEL		GL1E909SI
ST. STEEL - ST. STEEL		GL1E909II
ST. STEEL - ANTIMICROBIAL		GL1E909IIB
GREY - GREY	1075	GL1E209GG
GREY - BLACK		GL1E209GN
GREY - RED		GL1E209GR
GREY - GREEN		GL1E209GV
TITANIUM - TITANIUM		GL1E209TT
WHITE - WHITE		GL1E209BB
TITANIUM - STAINLESS STEEL		GL1E209TI
SATIN - STAINLESS STEEL		GL1E209SI
ST. STEEL - ST. STEEL		GL1E209II
ST. STEEL - ANTIMICROBIAL		GL1E209IIB

Available in 2 sizes: 775 mm and 1075 mm

Packaging:

The packaging includes:

- 1 main support
- 1 auxiliary support
- 1 horizontal tube
- Accessories bag with cover trims and fixing screws
- Assembly instructions
- Installation template

Locks

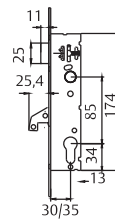

2240BA
Single point. 8mm follower.
Handed.

2230PA
Multiple point. 8mm follower.
Handed. Solution for single
leaf doors only.

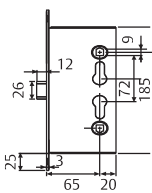

CF60
9 mm follower.
Reversible.

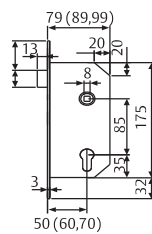

2035T
8 mm follower.
Handed. Cylinder not allow for
free opening doors.

2037F
8 mm follower.
Reversible. External cylinder
for locking & unlocking
external follower.

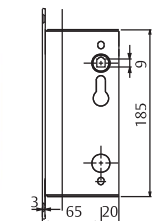

CF32
9 mm follower.
Reversible.

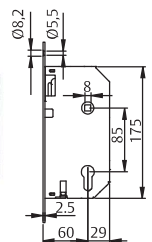

2032F
8 mm follower.
Reversible.

Outside trim for mortice solution panic exit device

For CF60 lock series



8 mm follower

Outside device	Product code
Blind plate	EDF90EXNE
Blind plate	EDF90EXIS16
Euro-profile plate	EDF91EXNE
Euro-profile	EDF91EXIS16
Sena Lever handle + euro-profile	SDF92EXNE
Sena handle euro-profile	SDF92EXIS16
Sena handle blind plate	SDF93EXNE
Sena handle blind	SDF93EXIS16
Pull knob	TTF72UNE
Pull knob	TTF72UIS16

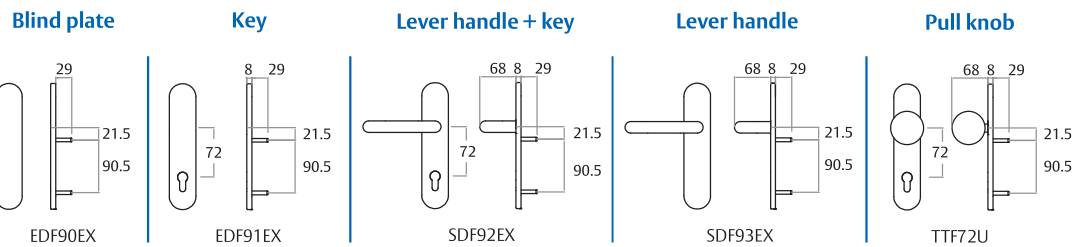

For 2035T, 2037F, 4039T, 2230BA and 2240PA lock series



8 mm follower

Outside device	Product code
Blind plate	EDF30EXNE
Blind plate	EDF30EXIS16
Euro-profile plate	EDF31EXNE
Euro-profile	EDF31EXIS16
Sena Lever handle + euro-profile	SDF32EXNE
Sena handle euro-profile	SDF32EXIS16
Sena handle blind plate	SDF33EXNE
Sena handle blind	SDF33EXIS16
Pull knob	TTF85UNE
Pull knob	TTF85UIS16

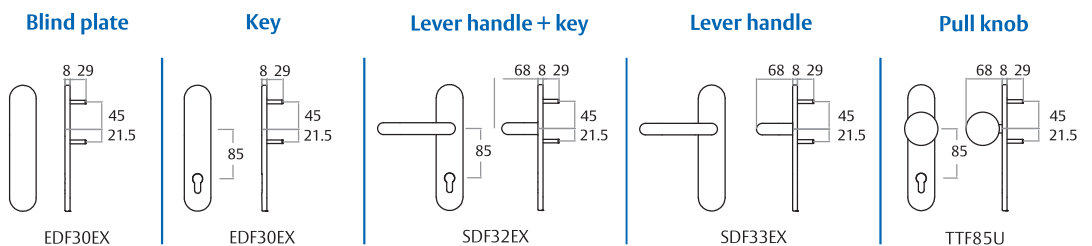

Compatible with other TESA ASSA ABLOY outside Access devices for CF locks such as MONOBLOC and AISI304 with 9mm follower as well as with other trims (CUBO, VECTOR, ...) and TRAFFIC systems.